

3.

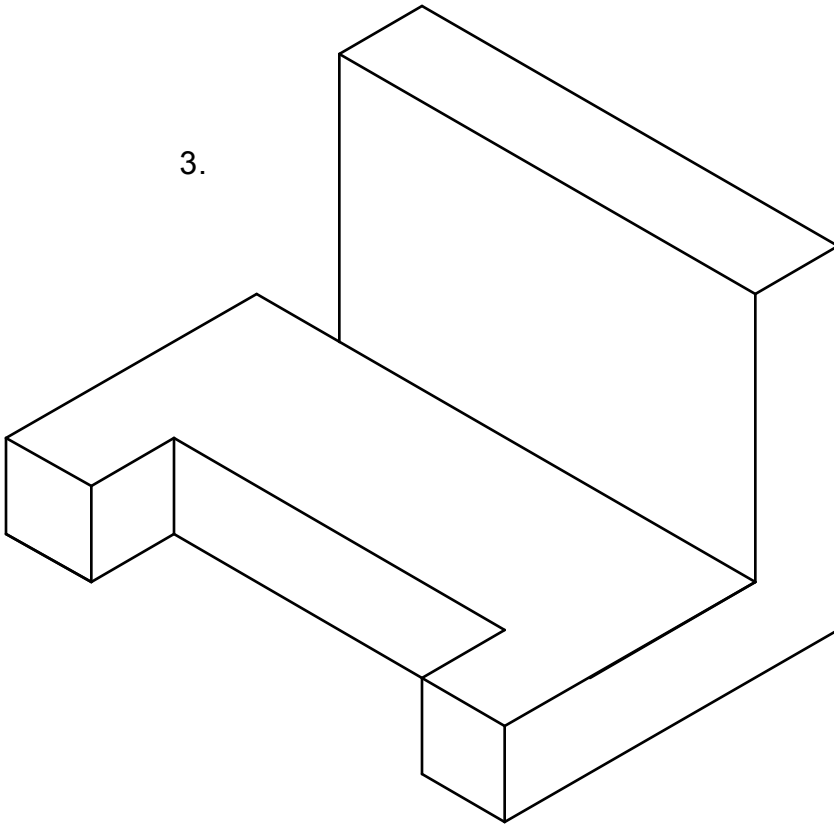

4.

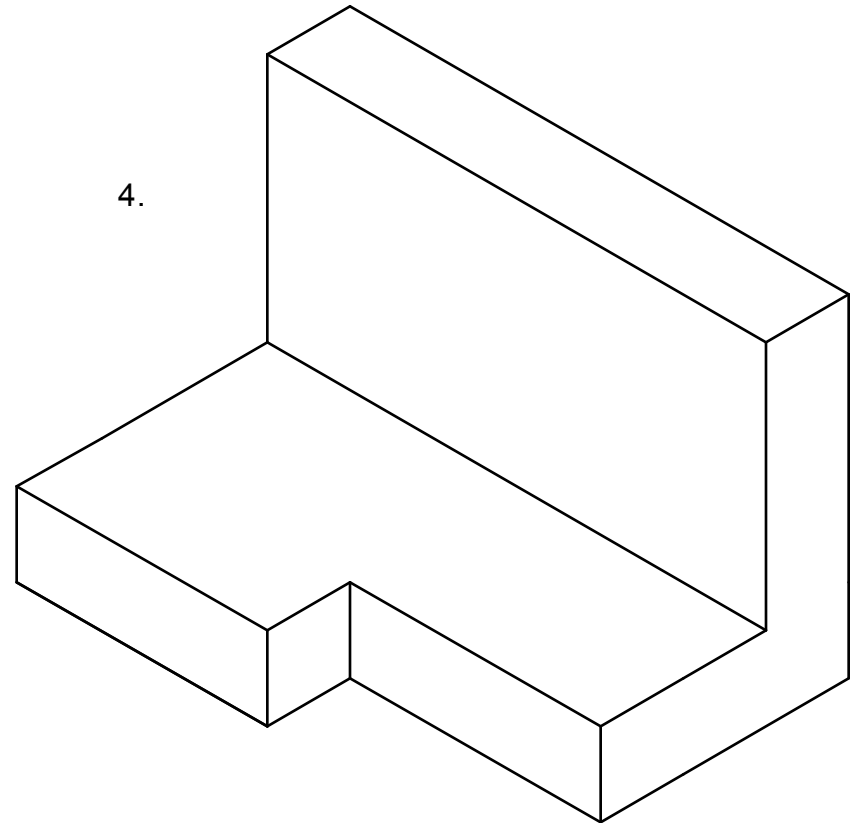

**STEVENSON HIGH SCHOOL**  
TECHNOLOGY EDUCATION DEPARTMENT  
TECHNICAL DRAWING PROGRAM

DRN BY: Joshua Song

DATE: 11.2.11

SCALE: 1:1

Isometric Multiview  
Sketching

1

1